



Gard Inc. Sdn. Bhd.
(200801031667)

No. 13, Jalan Budiman,
Budiman Business Park,
Bandar Sungai Long,
43000 Kajang,
Selangor, Malaysia.

- +603 8689 8018
- +603 8741 7300
- support@gardinc.com
- facebook.com/AireGardMY/
- AireGard TV
- www.AireGard.com

V.24.2



CLEAN AIR SOLUTIONS

ERV HF & URCAS SYSTEM

AireGard.
Life. Refreshed.

WHY IS INDOOR AIR QUALITY SO IMPORTANT ?

Indoor air quality is a vital requirement in situations with airborne diseases. As people spend nearly 90% of their time indoors, air pollutants may congregate 2-5 times more indoors and adversely affect productivity after staying indoors too long.

When people breathe, speak, exercise, sing, cough, or sneeze, respiratory fluids in the form of fine droplets and aerosol particles are formed. These droplets and particles can stay in the surrounding air for minutes to hours and may carry viruses that can easily cause the transmission of infections.

It is possible for fine droplets or aerosol particles to linger longer in enclosed spaces with inadequate ventilation or lack of air circulation, which can build-up in the air and cause a higher risk of infection.

Other than that, bad indoor air quality in enclosed spaces can also cause issues like Sick Building Syndrome (SBS). SBS causes people to suffer from headaches; irritation in their eyes, nose, and throat; lethargy; difficulty concentrating; nausea; dizziness; and other symptoms.

Most people have taken to staying home to work or study, which also directly causes them to suffer from SBS due to the lack of proper air circulation.

There are many factors that cause poor indoor air quality, such as excess humidity, poor ventilation, volatile organic compounds (VOC), dust, and other airborne pollutants. When all these factors are trapped indoors without a way to disperse or purify, it is no surprise that bad indoor air quality affects our daily lives so thoroughly.

AireGard® Clean Air Systems provide two major solutions to address poor IAQ in enclosed spaces.

Poor IAQ is associated with:



Respiratory Illnesses



Throat and Nasal Illnesses



Complications Related to Lung and Heart Conditions



Coughing



Carbon Monoxide Poisoning



Headaches



Allergic Reactions



Asthma Complications



Fatigue



SOLUTION #1: **Energy Recovery Ventilation**

Enthalpy Efficiency up to 90%



To prevent the spread of airborne diseases and issues like Sick Building Syndrome (SBS), proper air ventilation is a must. The AireGard ERV is a low energy whole space heat recovery unit with a high-efficiency heat exchanger that provides a constant supply of fresh tempered air into living spaces while keeping your electricity bills low.

WHAT DOES AN ENERGY RECOVERY VENTILATOR (ERV) DO?

An Energy Recovery Ventilator (ERV) is a cost efficient device that introduces fresh air into buildings, like office spaces and homes, which helps prevent airborne diseases by minimizing outside air loads to create a stable air environment while saving large amounts of energy. It can also help maintain the humidity and temperature in tropical climates like Malaysia.

When the air-conditioning is turned on, the energy of the cold air discharged from the room is used to pre-cool the hot air outside and then sent to the room, hence, an efficient energy recovery concept.

Efficient Energy Recovery Concept

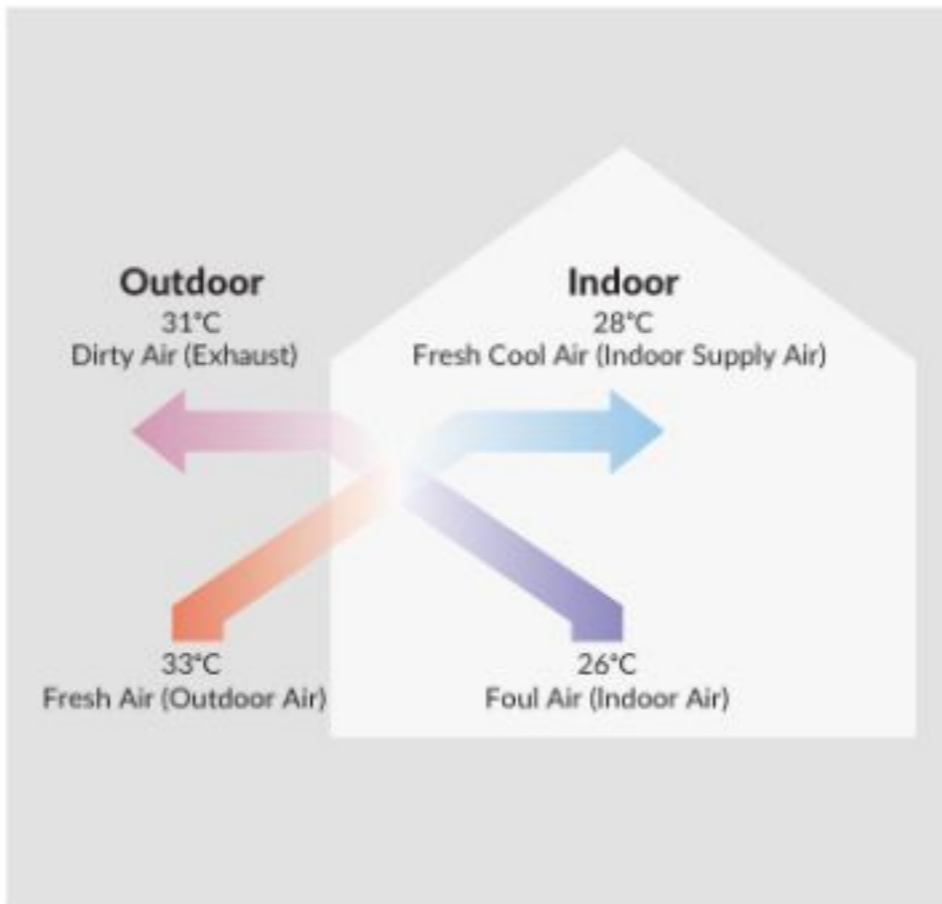

CLEANSE FRESH AIR TO HOME

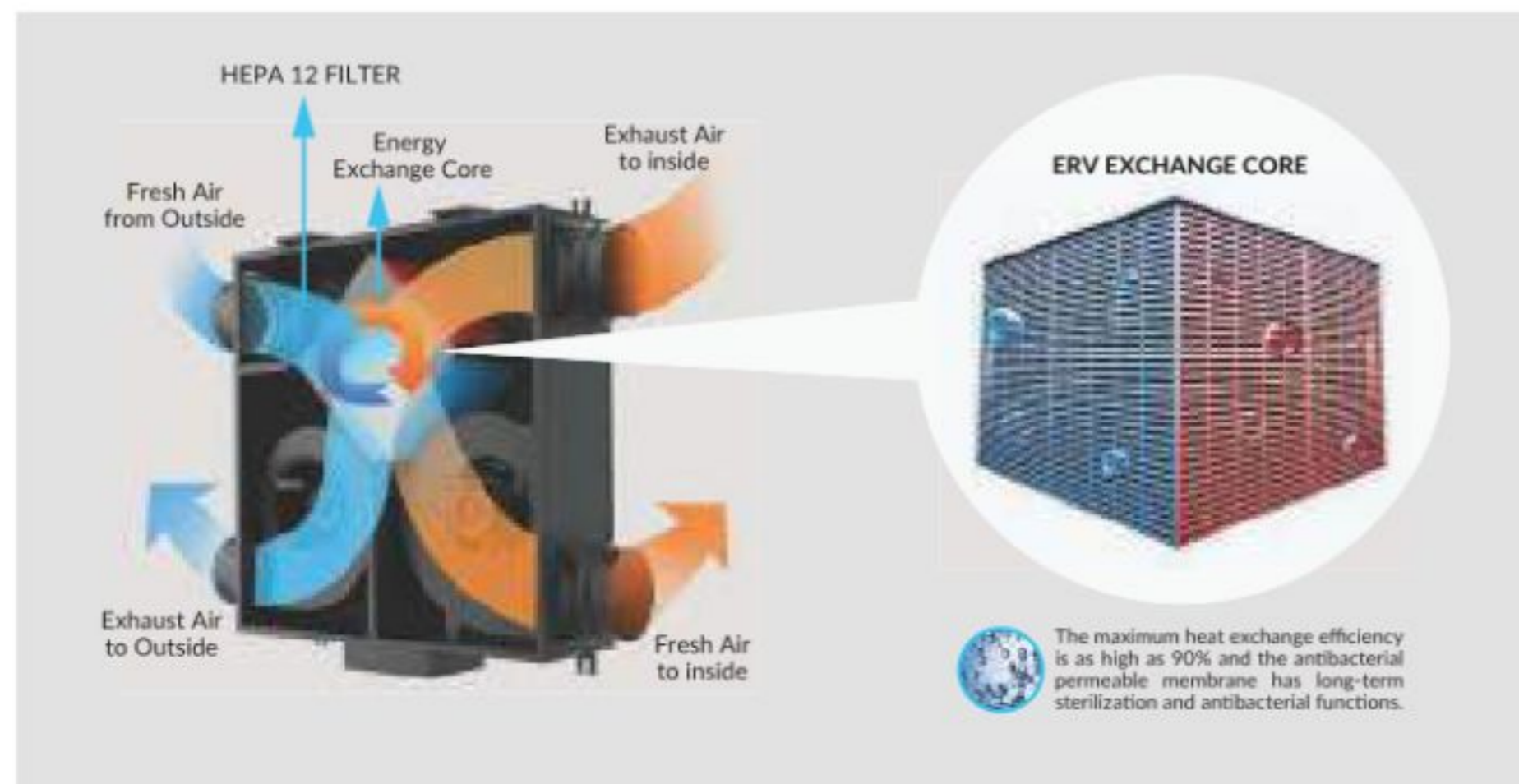

HOW DOES AN ENERGY RECOVERY VENTILATOR (ERV) WORK?

With an ERV, you can keep the windows closed and the air-conditioning on without worrying about the indoor air quality because it will keep the air fresh by supplying outside air while exhausting the stale indoor air.

When an ERV introduces fresh air with a maintained temperature and humidity into an enclosed space, it dilutes the concentration of virus particles in the air with a filter that removes stale air during air change.

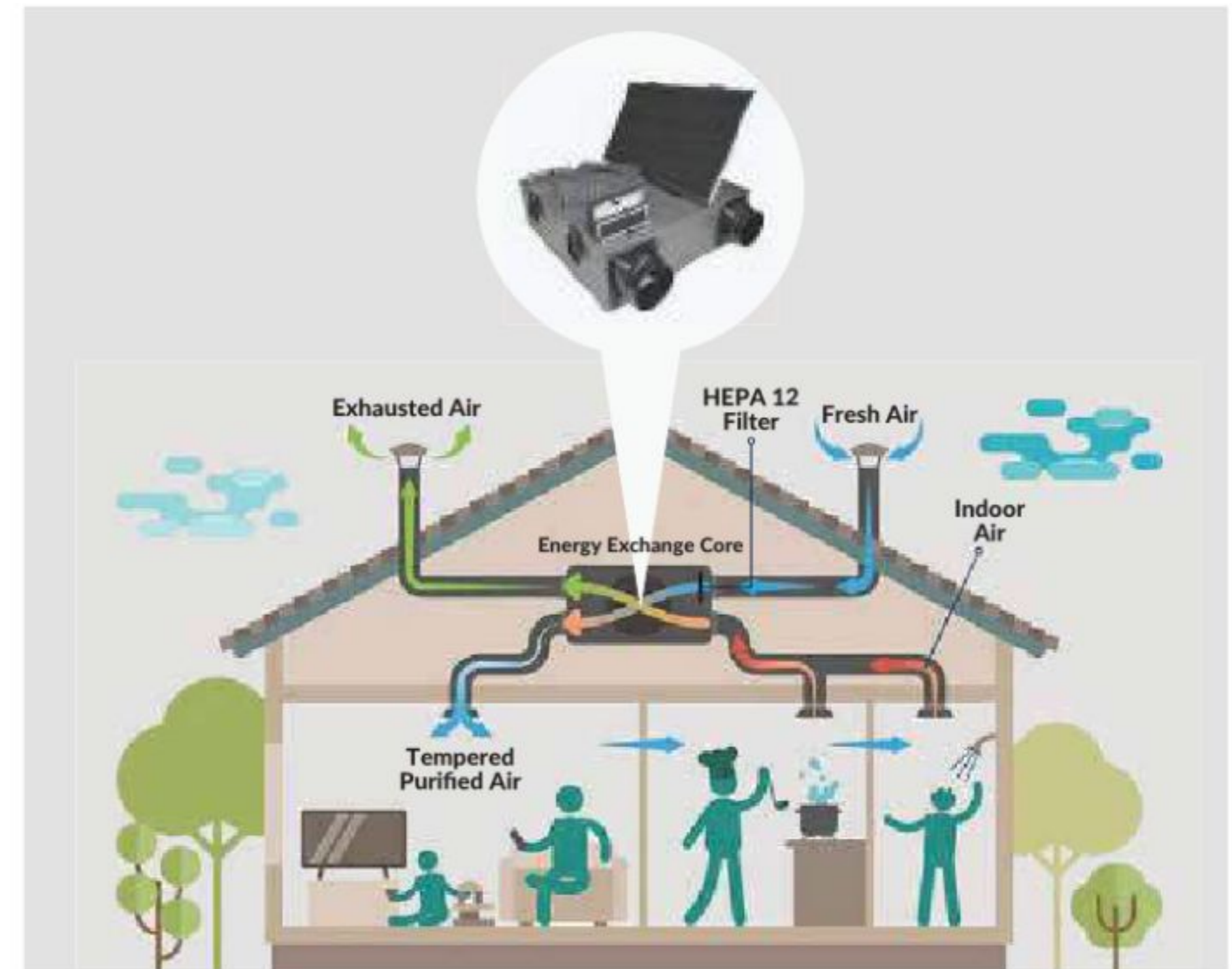

HOME VENTILATION SYSTEM

HEPA 12 Filter

AireGard® Energy Recovery Ventilators come with a medical grade HEPA 12 filter which can reliably filter up to 99.5% of airborne diseases and other pollutants that are 0.3 micron in size and below.

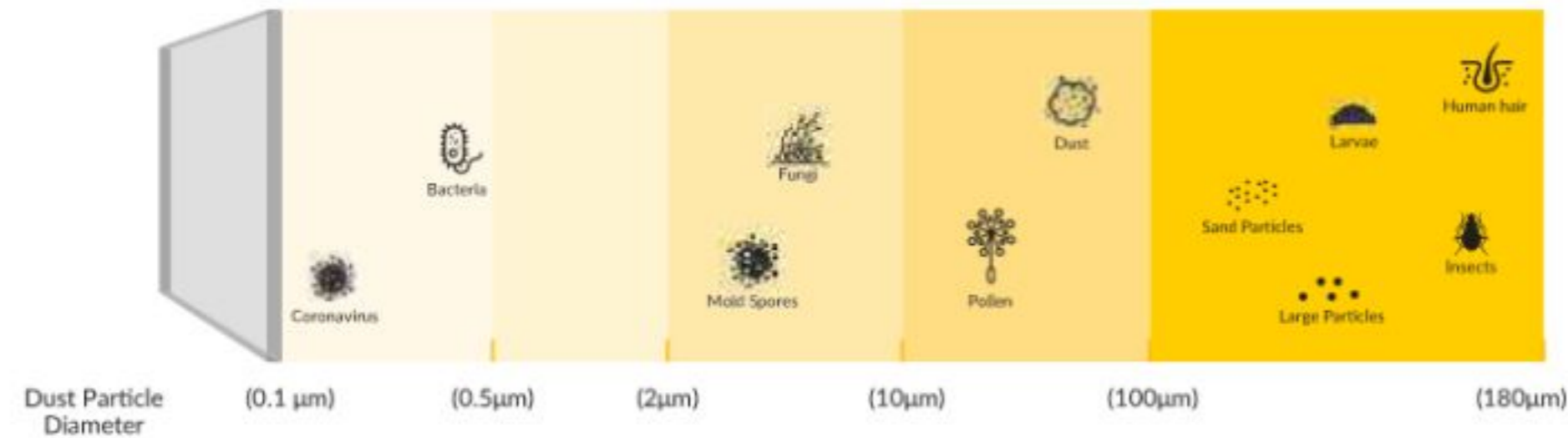

G5 Controller

Control your ERV from your smartphone with the world leading IOT Developer.

SERVICE REMINDER
Automated filter change reminder.

AUTO-PILOT
Automatically adjust air quality based on your ventilation needs.

TRACK AIR QUALITY CHANGES
Real-time information display on PM levels, temperature, and humidity levels.

TVOC
Display the real-time TVOC level.

4-ZONE CLIMATE CONTROL
Set your 7-day desired settings in 4 different time zones.

CHOOSE YOUR DESIRED SPEED
Low - Medium - High speed operation.

Powered by **tuya** intelligence cloud. Compatible with **iOS** and **android**.

HOW IS AN ENERGY RECOVERY VENTILATOR (ERV) COST EFFICIENT?

It provides a fresh supply of air with minimal loss of cool air indoors because of its energy recovering core. The outdoor air that carries heat will go through the ERV and enter the enclosed space as fresh air with a maintained temperature. When the colder indoor air exits through the ERV, up to 90% of the cold energy can be recovered and used to cool the hot outdoor air that is supplied into the enclosed space, without exerting excessive load onto the air conditioning system.

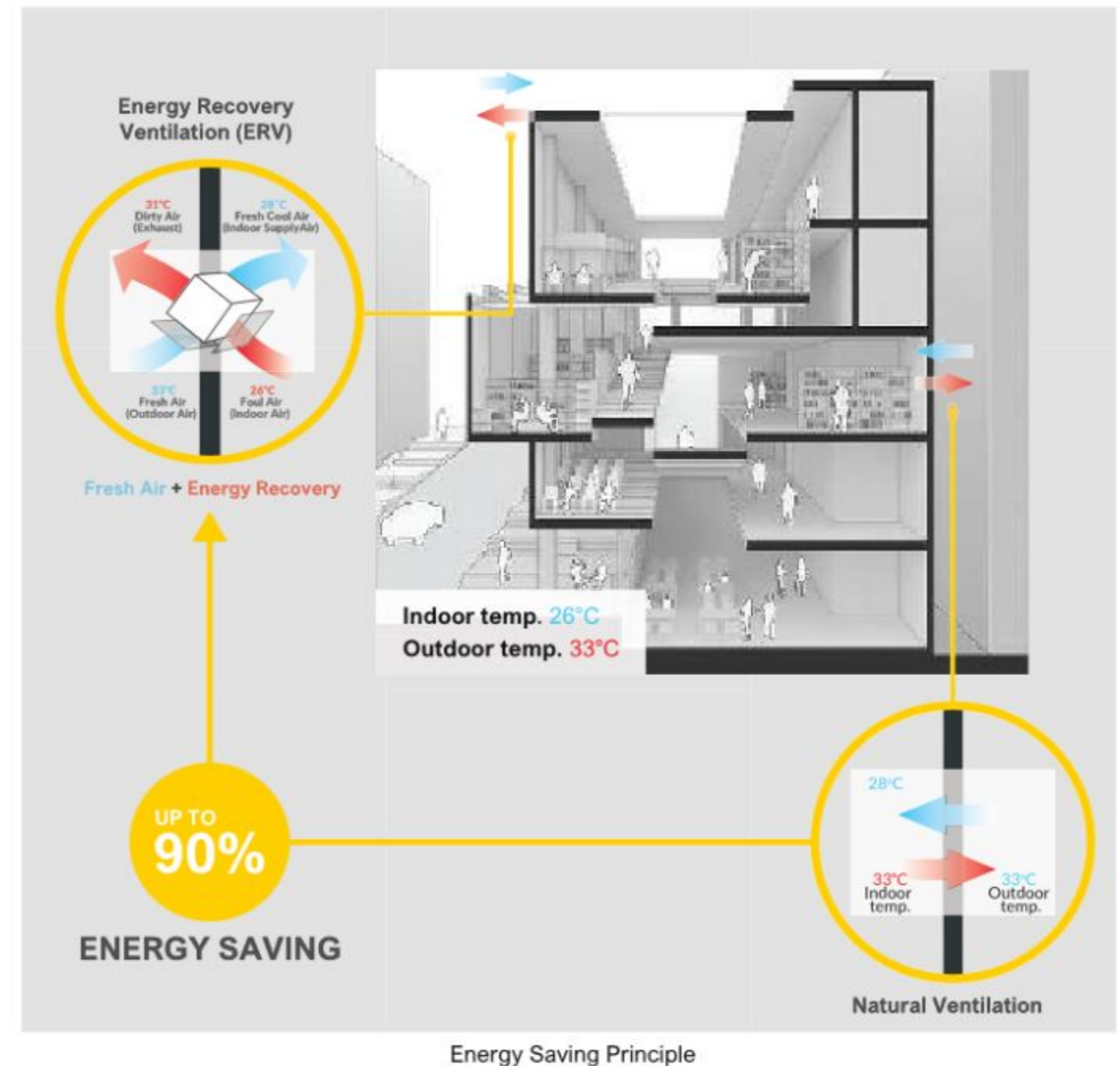

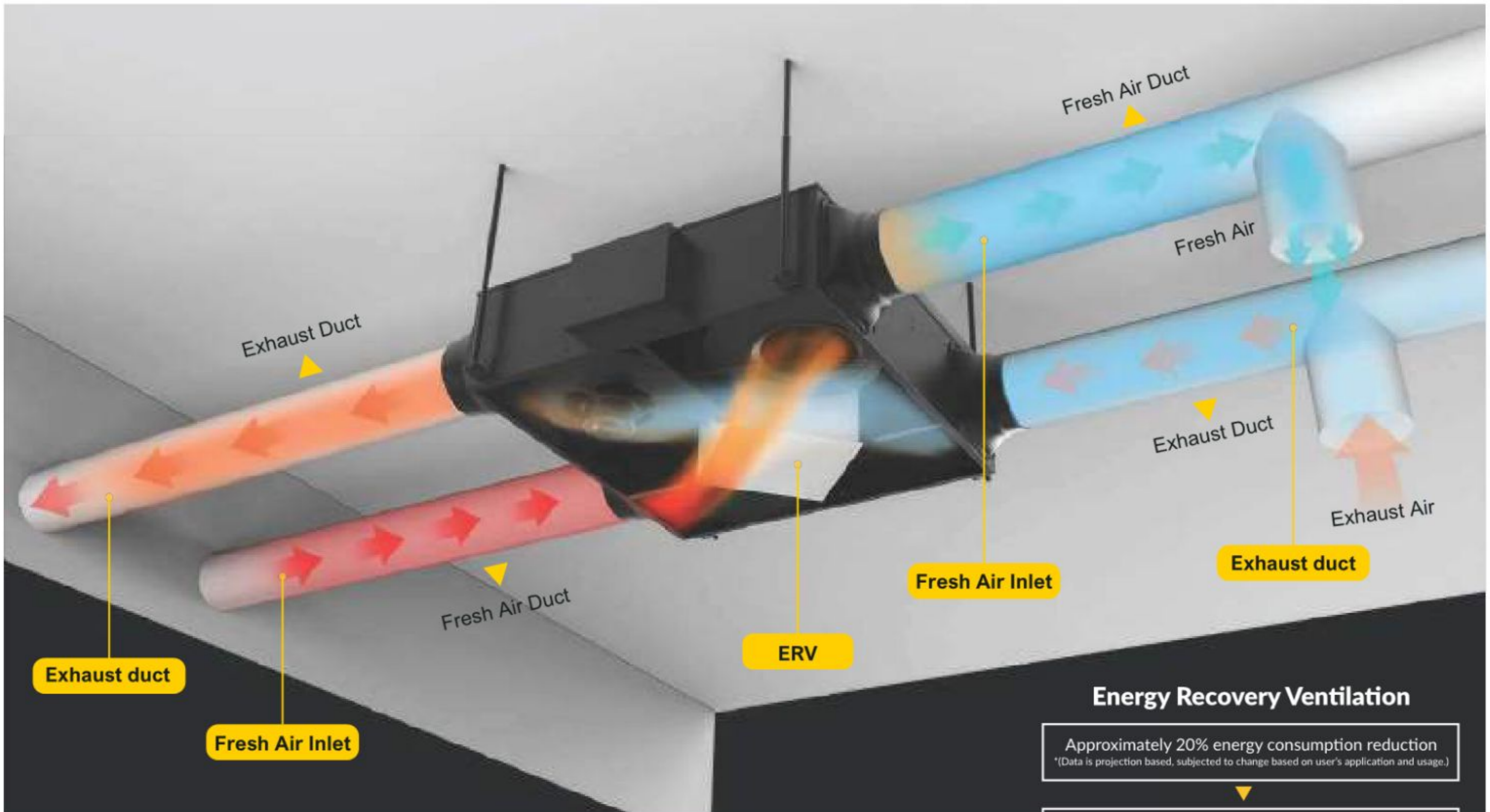

Exhaust duct

Fresh Air Inlet

Fresh Air Inlet

Exhaust duct

FILTRATION EFFECTIVENESS
99.5%

*BASED ON HEPA 12 FILTER TESTS.

Energy Recovery Ventilation

Approximately 20% energy consumption reduction
*(Data is projection based, subjected to change based on user's application and usage.)

Approximately 28% reduction in annual consumption of air conditioning

Approximately 6% in energy saved
Normal Ventilation Mode

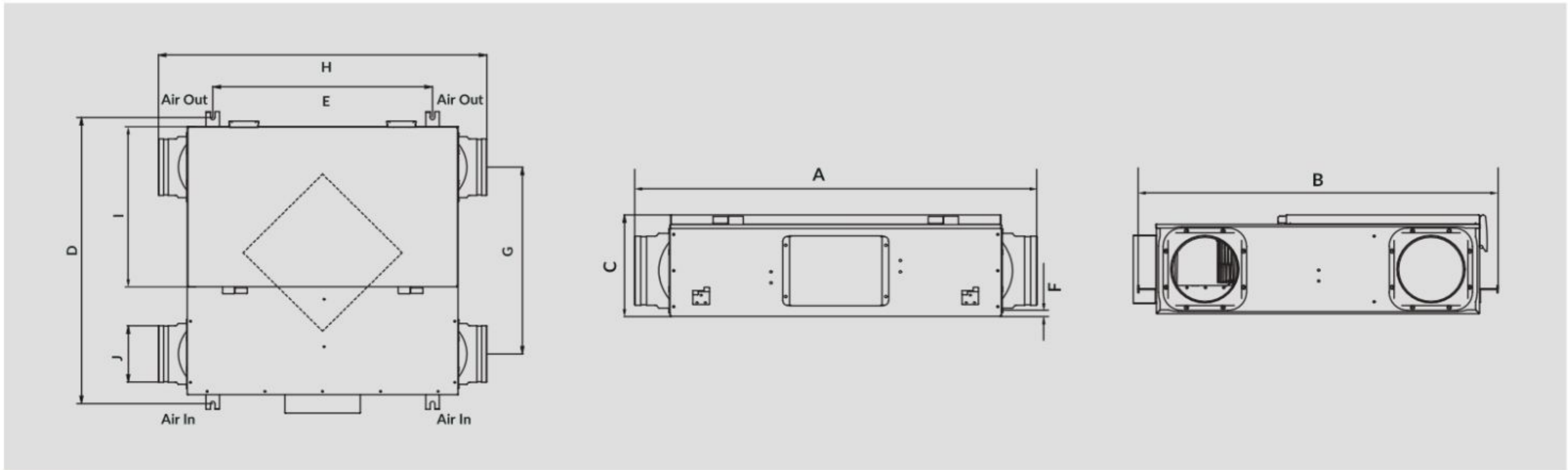

Specification & Dimensions

Model	A	B	C	D	E
ERV - 100 HF	867	854	222	816	602
ERV - 250 HF	893	854	252	816	602
ERV - 350 HF	885	854	282	816	602

Model	F	G	H	I	J
ERV - 100 HF	15	563	746	460	Ø 98
ERV - 250 HF	15	563	746	460	Ø 145
ERV - 350 HF	15	523	746	460	Ø 195

(mm)

Model	Voltage	Speed	Power (w)	Airflow (CFM)	Noise (dB)
ERV - 100 HF	220V - 50Hz	High	99	88	37
		Low	76	71	35
ERV - 250 HF	220V - 50Hz	High	200	206	41
		Low	160	147	39
ERV - 350 HF	220V - 50Hz	High	226	323	42
		Low	177	235	40

Model	Exchange Efficiency		Enthalpy Exchange Rate	
	Cooling	Heating	Cooling	Heating
ERV - 100 HF	64%	78%	65%	69%
	65%	79%	64%	73%
ERV - 250 HF	50%	77%	59%	68%
	65%	81%	64%	68%
ERV - 350 HF	56%	70%	56%	66%
	60%	71%	58%	67%



EFFECTIVE PROTECTION AGAINST AIRBORNE PATHOGENS & DISEASES

TESTED AND SHOWN 99.9% REDUCTION OF AIRBORNE SARS-COV2 IN A BSL2 LAB.

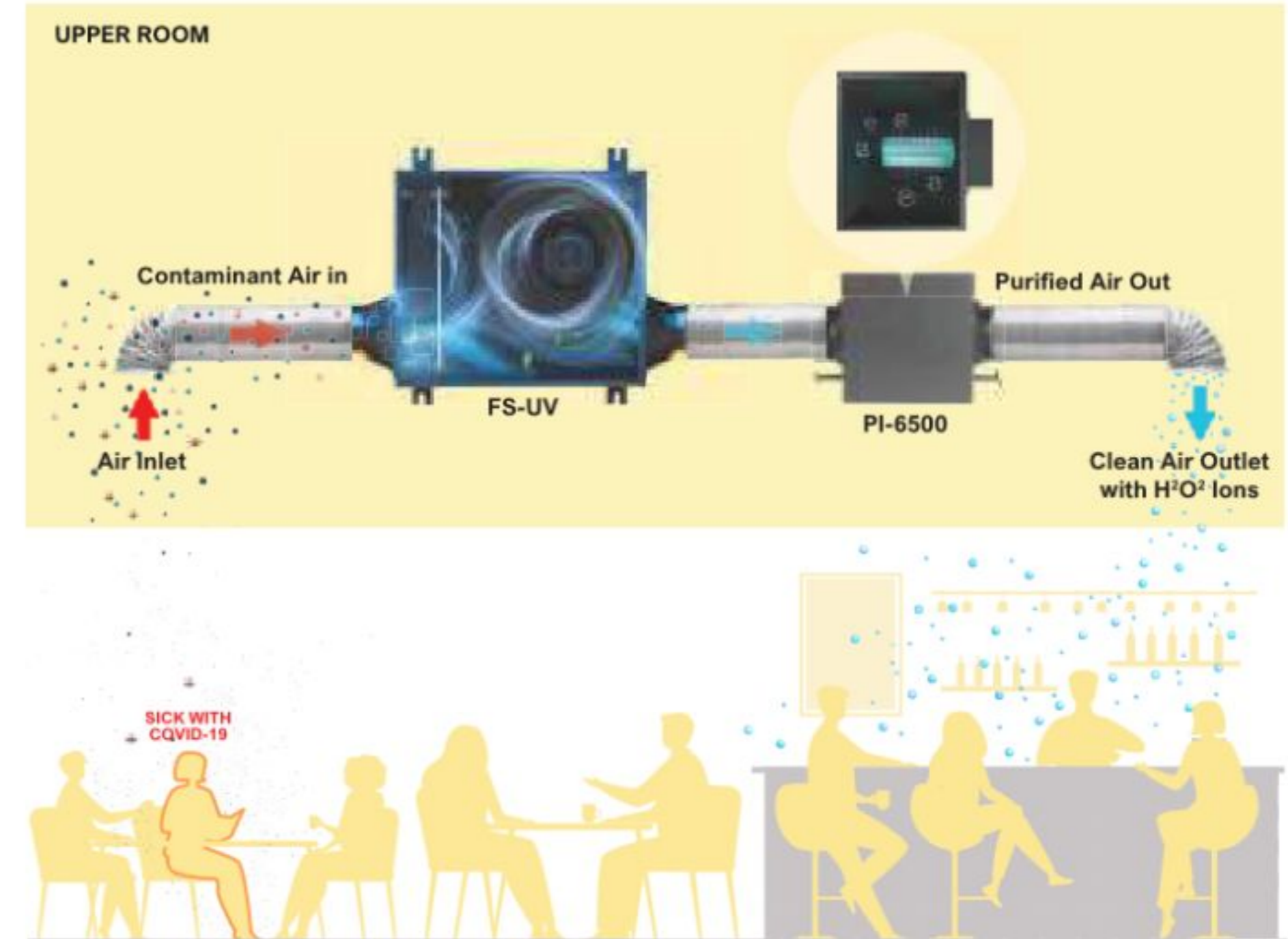

SOLUTION #2: UPPER ROOM CLEAN AIR SYSTEM (URCAS)

- AireGard® Fresh Air Ventilator
- AireGard® In-Duct Environmental Systems

ARCHIDEX®
STAR
AWARD
WINNER '21

The AireGard® Upper Room Clean Air System (URCAS) creates a complete system via the AireGard FS-UV and AireGard PI-6500, and is equipped with Advanced In-Duct Purification Technology that eliminates the airborne germ particles of diseases like COVID-19 and more.

Upper Room Clean Air System (URCAS)

Advanced Protection Against Airborne Pathogens & Diseases

How does it work?

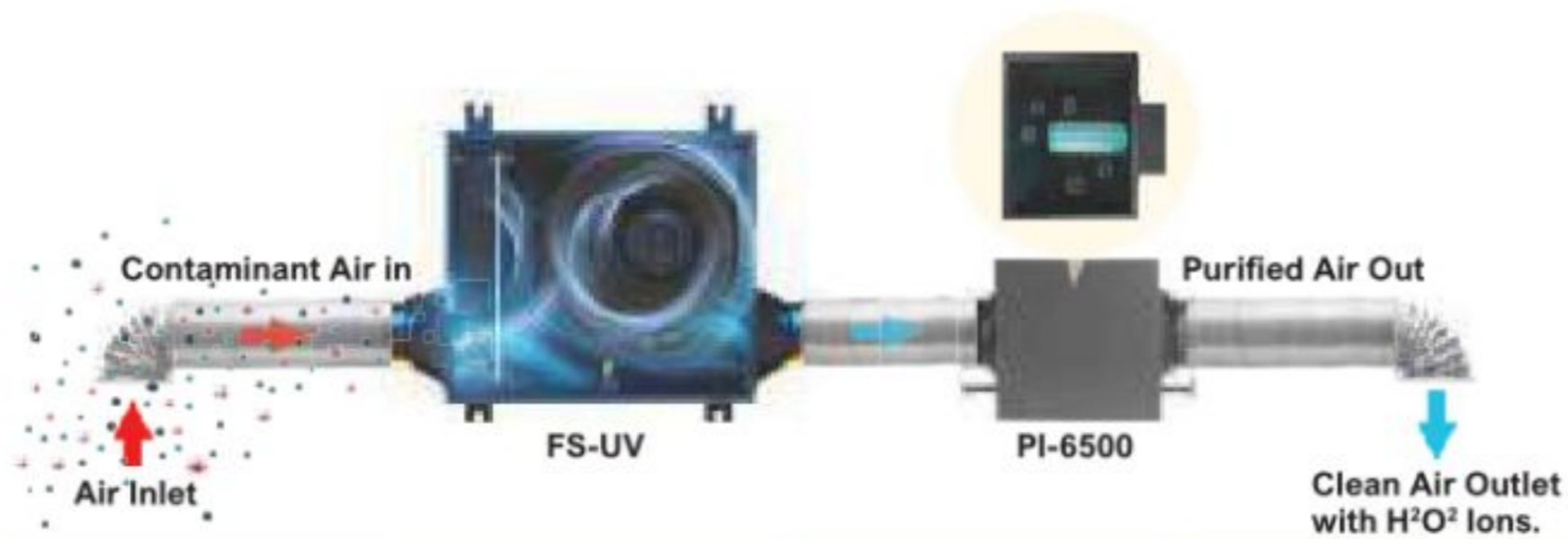

<p>PRE-FILTER</p> <p>A robust, washable pre-filter that provides the first line of defense against larger particulates such as dust, dirt, and hair.</p>	<p>HEPA 12 FILTER WITH UVC SUPPORT</p> <p>A high-grade HEPA 12 filter traps ultrafine particulates and pathogens to deliver world-class purification performance in tandem with a high intensity UVC light for further nullification.</p>	<p>CARBON FILTER</p> <p>A premium quality activated carbon filter that neutralizes gasses, odors, and volatile organic compounds (VOCs)</p>	<p>PCO CHAMBER</p> <p>Our Advanced In-Duct Purification Technology safely facilitates Photocatalytic Oxidation (PCO) to deactivate pathogens with a proven and tested eradication of airborne SARS-CoV2 at 99.9% efficiency within a 30-minute time frame.</p>

The AireGard® URCAS solution introduces filtered fresh air into enclosed spaces, which effectively dilutes the concentration of all airborne germ particles in the air with increased air change in a targeted area via Super Oxidizers created by the PCO process.

The filtered air will be cycled back into the indoor space and effectively undergo the same filtering treatment during air change, thus keeping the targeted area up to 1,000 sqft (per URCAS unit) secure and clean with the recirculatory application feature.

Features

- Improved indoor air change cycles for better ventilation.
- Reduction in airborne and surface microbials such as viruses, bacteria, and mold with a proven and tested eradication of germ particles at 99.9% efficiency within a 30-minute time frame.
- Reduction of harmful compounds and gasses such as VOC, smoke, odors, allergens, dust, and particulate matters.
- Easy installation of the URCAS solution for targeted clean air delivery with a guaranteed peace of mind.
- A 3-year warranty period.

Flexible Airflow Applications

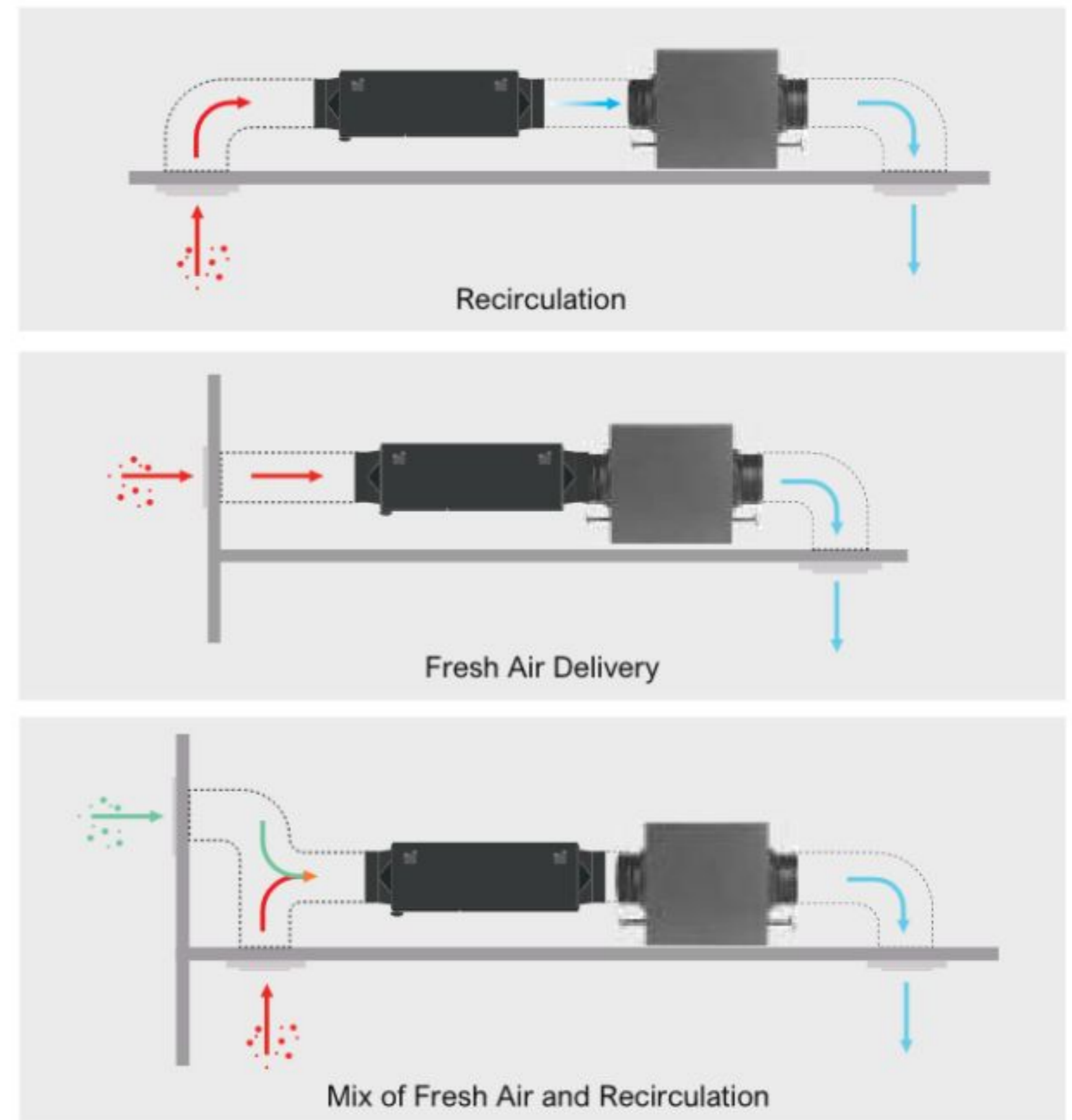

Fresh Air Ventilator (FS-UV Series)

The AireGard® FS-UV is a Fresh Air Ventilator that introduces fresh air into enclosed spaces. Filtered with a HEPA 12 medical grade filter, this ventilator effectively filters up to 99% of airborne contaminants while eradicating them with its built-in UVC light that targets an enclosed area with increased air change.

Features

	HEPA 12 High efficiency filtration media removes up to 99.9% of 0.3 micron particulate matter.	SLIM DESIGN Low body height for easy fitment in almost any ceiling space.
	QUIET OPERATION High performance motor ensures low electrical consumptions and whisper quiet operation.	UV LIGHT Uses UV-C lights at 254nm to inactivate viruses, bacteria, and germs that are trapped in the filters as well as in the airstream.
	CARBON FILTER Absorbs formaldehyde, benzene & harmful chemicals (VOCs).	3-YEAR WARRANTY Refer to our warranty terms and conditions for more information.

Dimensions

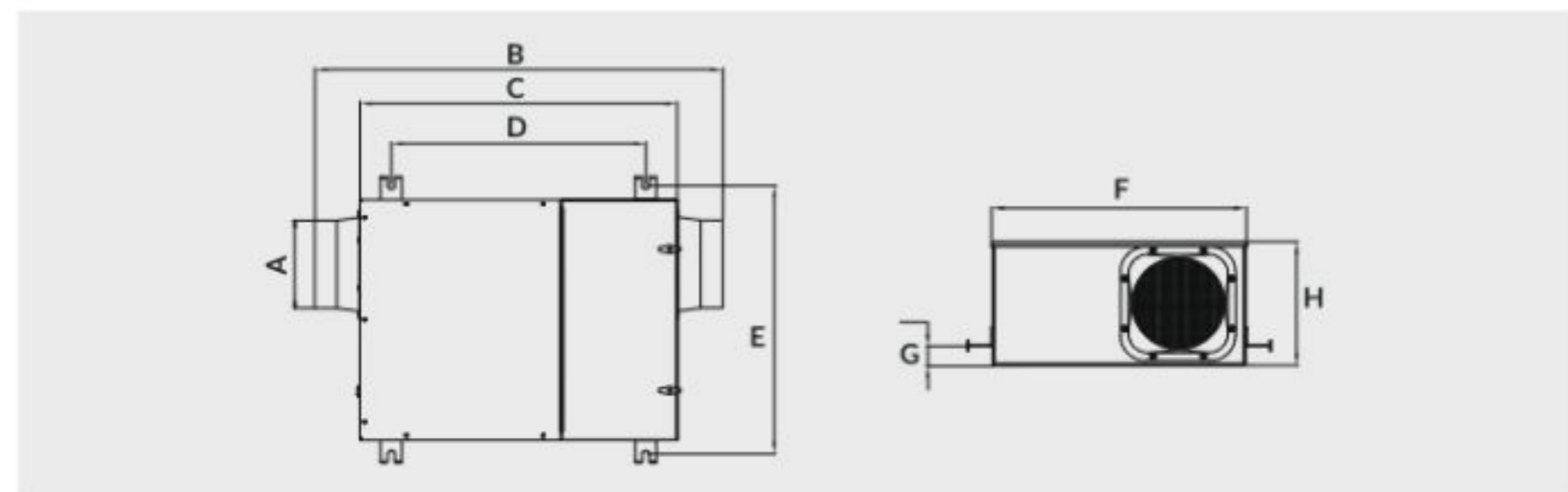

Model	A	B	C	D	E	F	G	H
FS-100UV	Ø98	701	523	420	447	400	32	121
FS-300UV	Ø146	673	523	420	447	400	32	196
FS-450UV	Ø194	700	523	420	447	400	32	246

(mm)

Specifications

Model	Size	Speed	Specifications				
			Power (W)	Airflow (cfm)	Air Pressure (Pa)	Noise (dB)	Voltage/Frequency
FS-100UV	Ø100	H	45	106	447	31	220V/50Hz
		L	30	70		30	
FS-300UV	Ø150	H	75	265	447	38	220V/50Hz
		L	55	206		36	
FS-450UV	Ø200	H	115	440	447	42	220V/50Hz
		L	85	323		40	

Airflow Chart

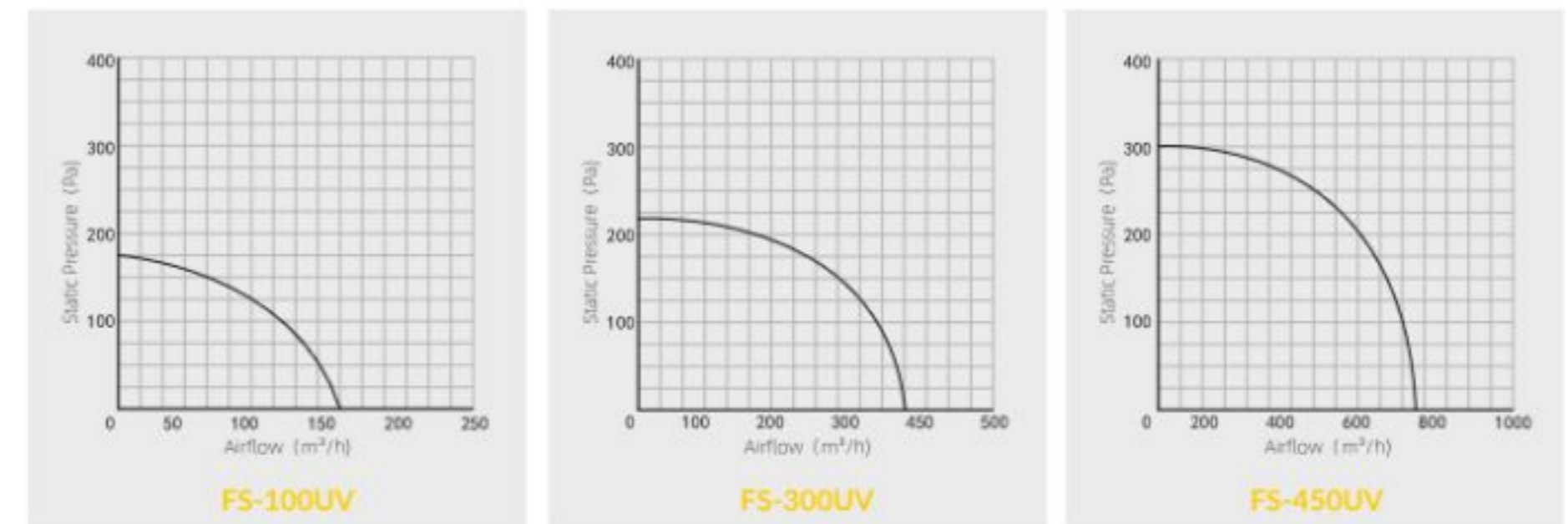

Easy Installation

Whole house ventilation solution for a better indoor environment.

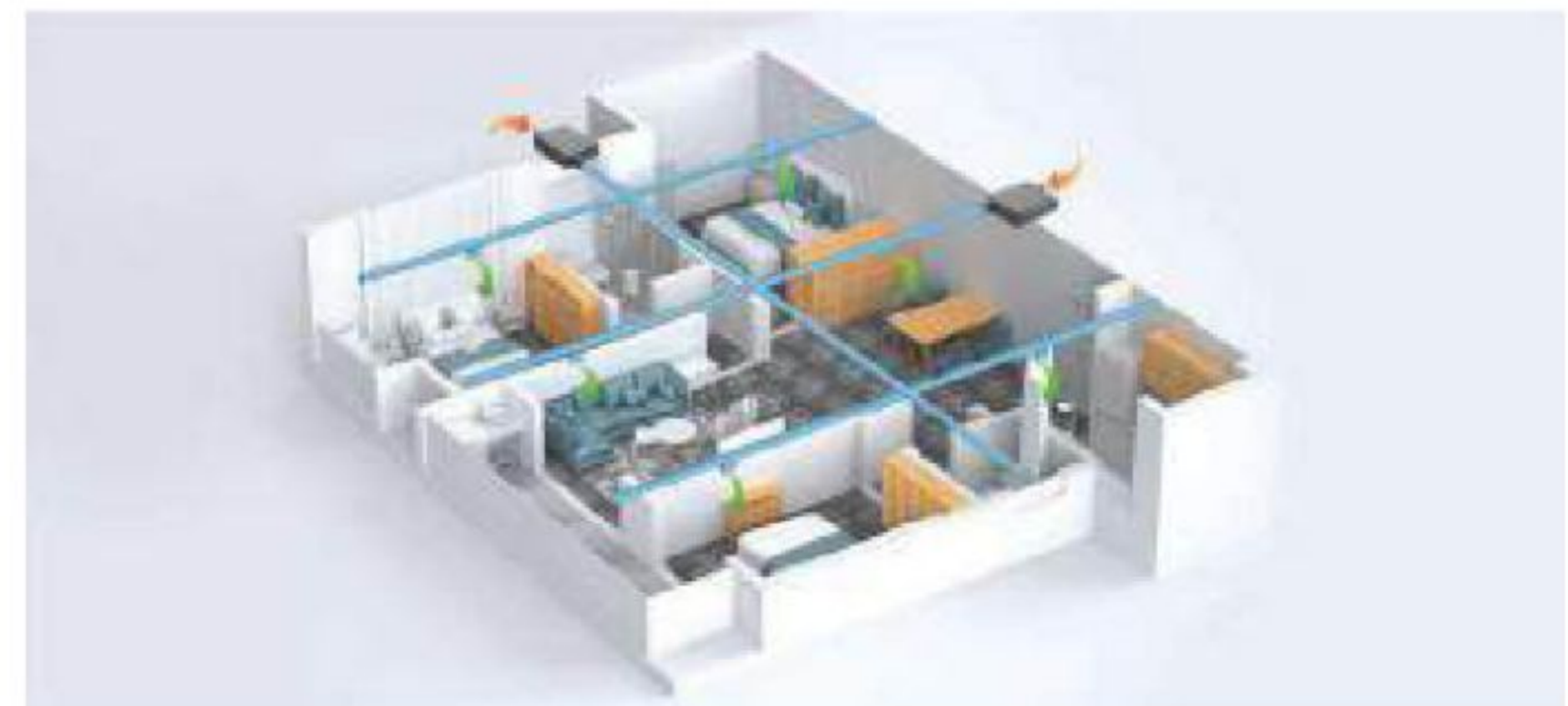

Advanced In-Duct Purification Technology (PI-6500)

The AireGard® PI-6500 uses a revolutionary Advanced In-Duct Purification Technology, Photocatalytic Oxidation (PCO), to effectively eliminate airborne and surface pathogens up to 99.9% efficiency within a 30-minute time frame. The purification process is both mercury free and zero ozone compliant (conforms to US FDA requirements), making it safe and suitable for all spaces.

Features

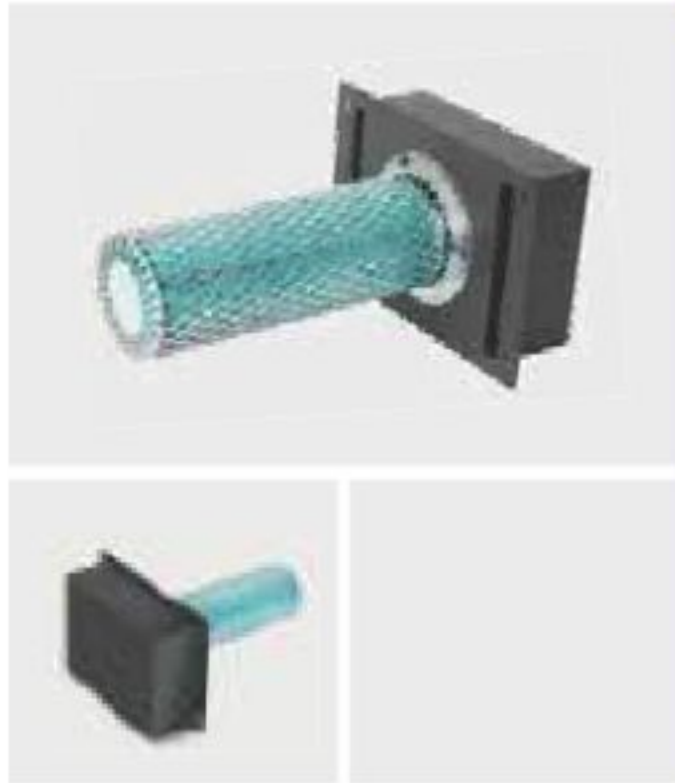

- 1.Reduction in airborne and surface microbials such as viruses, bacteria, and mold with a proven and tested eradication of germ particles at 99.9% efficiency within a 30-minute time frame.
- 2.Reduction of harmful compounds and gasses such as VOC, smoke, odors, allergens, dust, and particulate matters.
- 3.Compatible with HVAC system.
- 4.Zero Ozone & Mercury Compliant.
- 5.A 3-year warranty period.





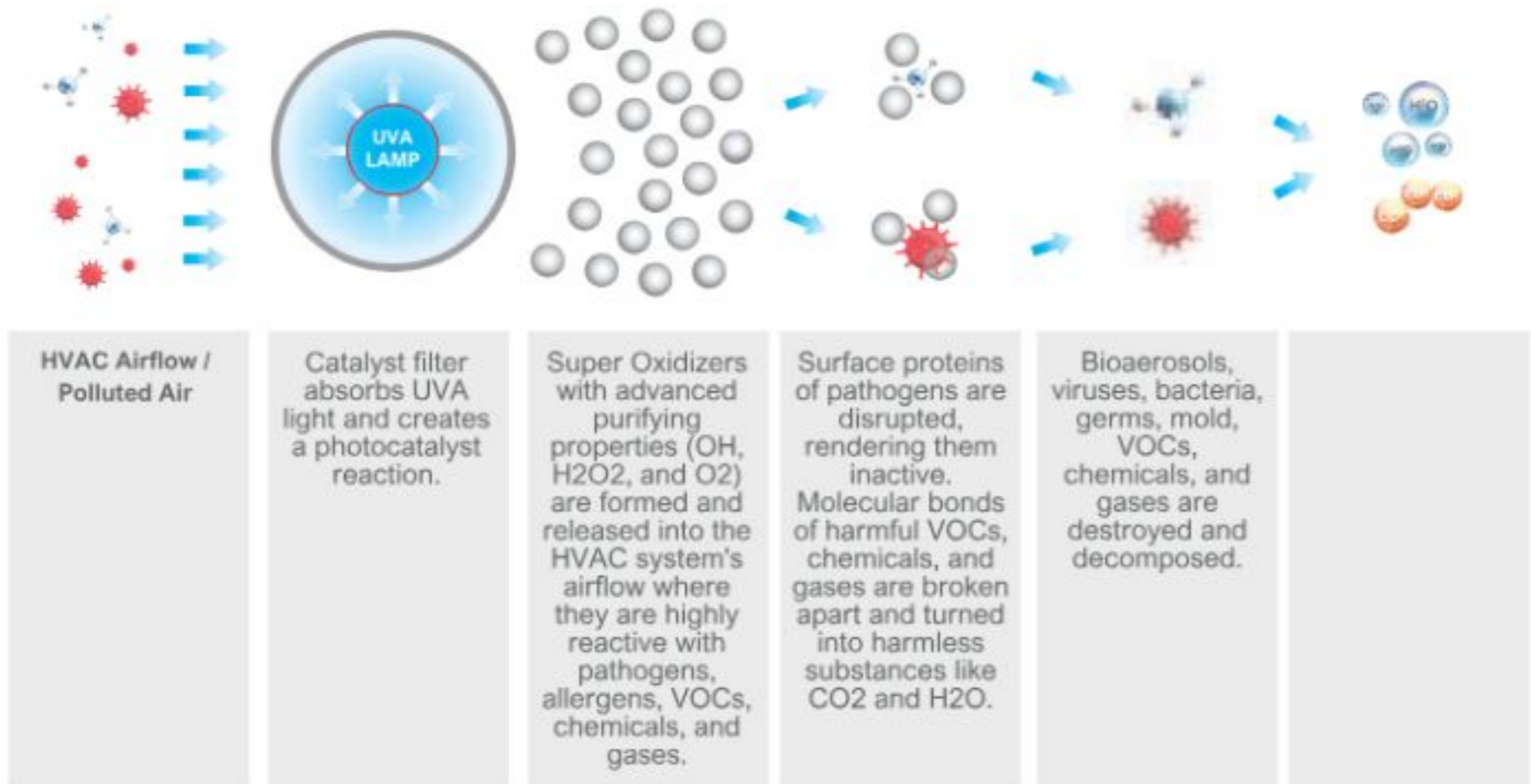

Tested and Proven

<p>ALS GLOBAL</p>	
<p>SGS</p> 	

How Does it Work?



Benefits from the PCO Process:

			
<p>Hydroxyl Radicals (OH)</p>	<p>Hydroperoxides (H₂O₂)</p>	<p>Negative Oxygen Ion (O⁻)</p>	<p>Hydroxides (OH⁻)</p>
			
<p>Kills up to 99% of bacteria, mold, and viruses.</p>	<p>Decomposing volatile organic compounds (VOC) to eliminate odors.</p>	<p>Reducing airborne particulates (dust, dander, pollen, mold spores).</p>	

Specifications

Model	Protection Coverage	Wattage	Voltage (V)	Rated Life Span	Drilling Size	Fixed Hole Size
PI-6500	up to 1,000 Sq. Ft	36 w	220 V	9,000 hours	110 mm	180x110
Model	Product Size	Virucidal Efficiency against SARS-CoV2				
PI-6500	200x140x280	99.5% in 30mins				

Dimensions

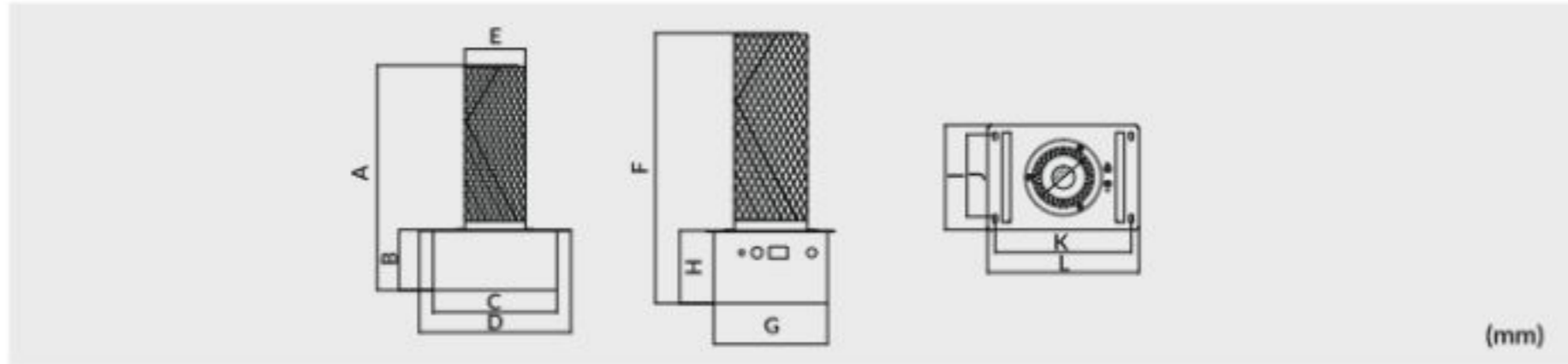

Model	A	B	C	D	E	F	G	H	I	J	K	L
PI-6500	300	80.5	163.5	200	Ø80	300	125	80.5	140	110	180	200



Easy Installation

HVAC COMPATIBLE

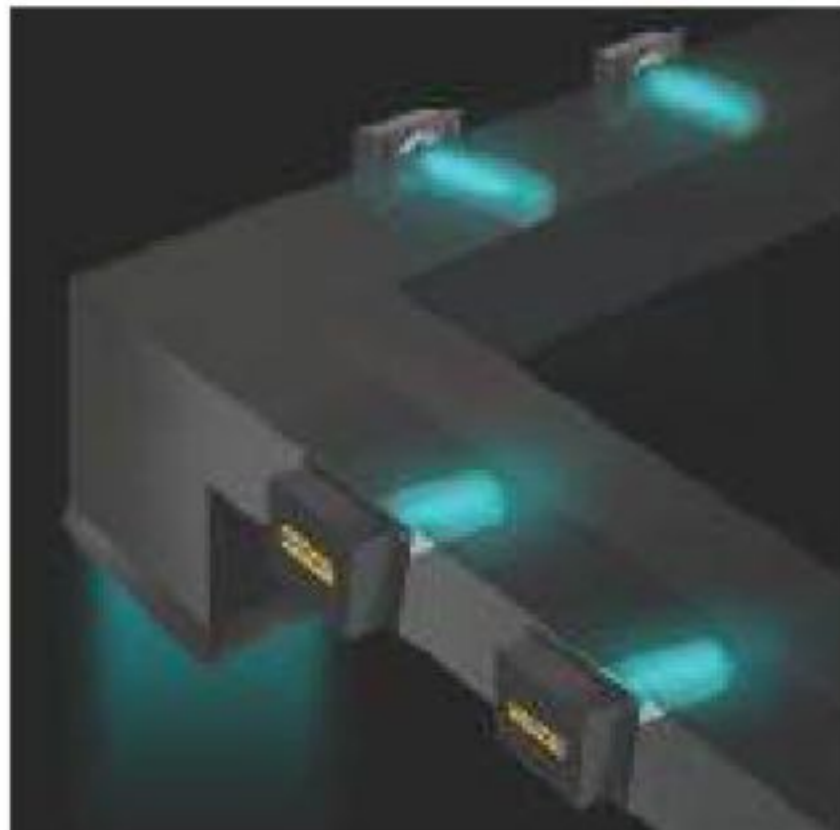

CEILING MOUNTED

